

Downlight



IP54 Ingress Protection



LED COB



Die-Cast Housing



Faceted Reflector

Dimensions

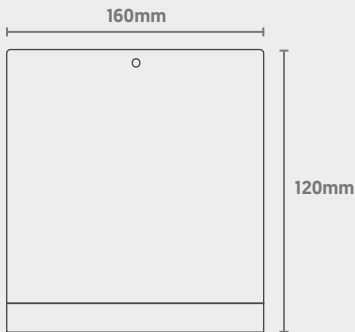

Light Source Energy Rating

Photometric Data

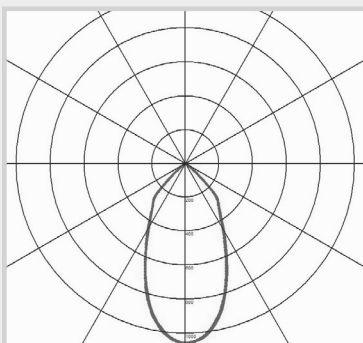

QCan

Surface Downlight

CODE: QCAN-20-160NW/BK

QVIS[®]
LIGHTING & SECURITY



Power	Efficacy	Output	Kelvin
20W	115Lm/cW	2300Lm	4000K

Technical

Input Voltage	AC 200-240V
Reflector Type	Faceted
Colour Rendering Index	>80
Beam Spread	60°
Power Factor	>0.9
Lamp Type	COB
Operating Temp.	-20 to +40°C
Materials	Die-Cast
IP Rating	IP54
Dimmable	On Request
Dimensions	160mm x 120mm
Weight	1.23kg
MacAdam Step	<3
Lifetime	50,000 hours, L90-B10 (Ta 25 °C)
CE Standards	EN60598-1, EN 60598 2-5, EN62493, EN55015, EN61547, EN61000-3-2, EN61000-3-3, EN62722-1, EN62722-2-1 and EN50581
CE Directives	LVD, EMC, ERP & RoHS