

# Surface & Suspended

## QPac Linear Batten



CODE: QPAC-30-1500NW/EM/PIR

- Easy-Release Diffuser
- BESA Mounting Points
- Conduit Side Entry
- Metal Housing

### Dimensions

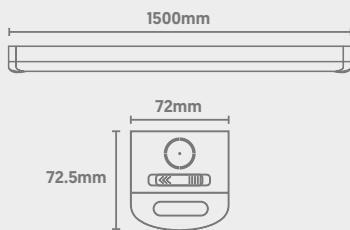

PIR Sensor Info  
on Following Page



Power	Efficacy	Output	Kelvin
30W [Emergency 3W]	120Lm/cW	3600Lm [Emergency 360Lm]	4000K

### Technical

Input Voltage	AC 220-240V
Beam Spread	120°
Colour Rendering Index	>80
Power Factor	>0.9
Operating Temp.	-20 to +40°C
Materials	Metal & Polycarbonate
IP Rating	IP20
Dimmable	On Request
Dimensions	1500mm x 72.5mm x 72mm
Weight	2.07kg
MacAdam Step	<3
Emergency Output	3 Hours [3W]
Lifetime	50,000 hours, L70-B10 [Ta 25 °C]
CE Standards	EN60598-1, EN62493, EN55015, EN61547, EN61000-3-2, EN61000-3-3, EN62722-1, EN62722-2-1 and EN50581
CE Directives	LVD, EMC, ERP & RoHS

**A ↑ G** **E** Light Source Energy Rating

### Photometric Data

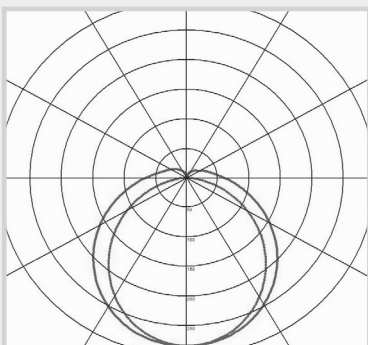

# Surface & Suspended



Day & Night Operation



10m Detection Distance



360° Detection Range



Up to 6m Install Height  
(2m to 6m is recommended for optimal performance)

## Dimensions

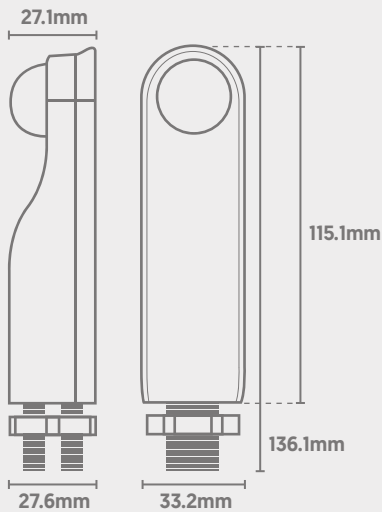

# QPac

## PIR Sensor



## PIR Specifications

Daylight Sensor	<3Lx to 2000Lx (Adjustable)
Hold Time	Min: 10s±3s; Max: 30min±2min
Stand-By Period	5min, 10min, 15min, 30min, 60min, +∞
Detection Range	50% / 75% / 100% (360°)
Detection Distance	Up to 10m (24°C)
Detection Moving Speed	0.5-1.5m/s
Automatic Lighting Range	10Lx to 300Lx
Stand-By Dimming Level	OFF / 10% / 20% / 30%



## Technical

Power Source	AC 220-240V
Power Frequency	50/60 Hz
Maximum Switching	6A
Rated Load	Between 500W and 1200W
Power Consumption	Approximately 0.5W
Cable Specification	18AWG-1007
Operating Temperature	-20 to +40°C
Operating Humidity	<93% RH
Installation Height	2m to 6m
Material	Polycarbonate
IP Rating	IP65 After Installation

# Surface & Suspended



Day & Night Operation



10m Detection Distance



360° Detection Range



Up to 6m Install Height  
(2m to 6m is recommended for optimal performance)

## Dimensions

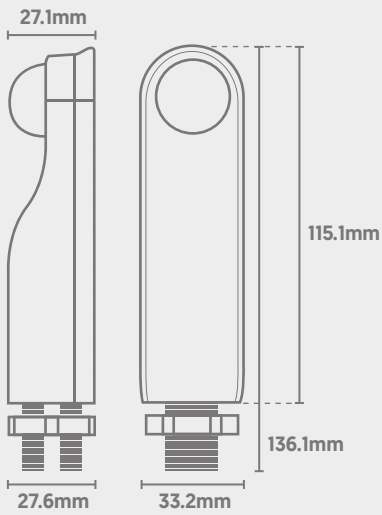

# QPac

## PIR Sensor



## Detection Diagram

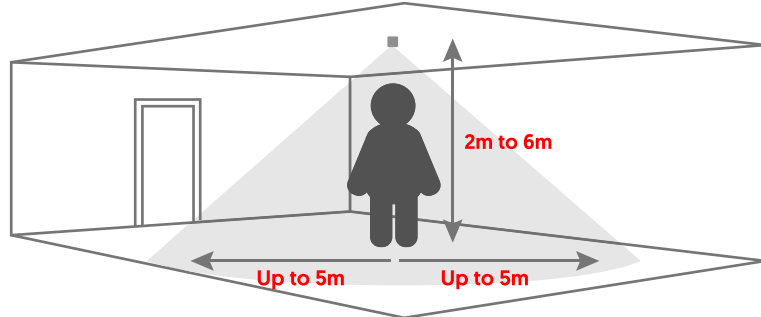

## Wiring Diagram

