

Surface & Suspended

QPac Linear Batten

QVIS[®]
LED LIGHTING

CODE: QPAC-20-1200NW/ME

- Easy-Release Diffuser
- BESA Mounting Points
- Conduit Side Entry
- Metal Housing

Dimensions

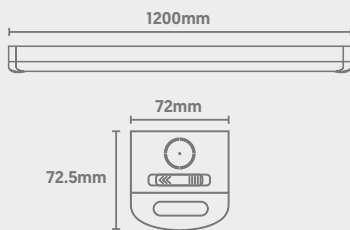

Microwave Sensor
Info on Following Pages

3HR
EMERGENCY
DURATION

5
YEARS
WARRANTY
+ 1 YEAR ON SITE*

Power	Efficacy	Output	Kelvin
20W [Emergency 3W]	120Lm/cW	2400Lm [Emergency 360Lm]	4000K

Technical

Input Voltage	AC 220-240V
Beam Spread	120°
Colour Rendering Index	>80
Power Factor	>0.9
Operating Temp.	-20 to +40°C
Materials	Metal & Polycarbonate
IP Rating	IP20
Dimmable	Microwave Sensor
Dimensions	1200mm x 72.5mm x 72mm
Weight	1.76kg
MacAdam Step	<3
Emergency Output	3 Hours [3W]
Lifetime	50,000 hours, L70-B10 (Ta 25 °C)
CE Standards	EN60598-1, EN62493, EN55015, EN61547, EN61000-3-2, EN61000-3-3, EN62722-1, EN62722-2-1 and EN50581
CE Directives	LVD, EMC, ERP & RoHS

A
↑
G **E** Light Source
Energy Rating

Photometric Data

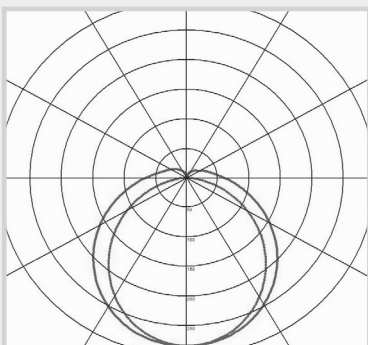

QPac

Microwave Sensor

Dimensions

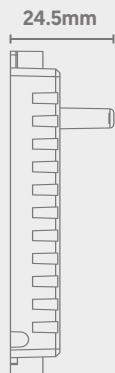
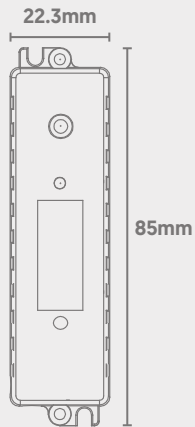

Main Specifications

Solution Type	Rod Antenna
Input	DC 12V
Dimmable	0-10V
Controls	DIP Switch
Dimensions	85mm x 22.3mm x 24.5mm

Technical

Operating Voltage	DC 12V
Operating Current	<25mA
Stand-By Power	<0.5W
Mounting Height	2.5m to 4.5m (8.2ft. to 14.76ft.)
Detection Height	4m to 10m (13.12ft. to 32.8ft.)
Microwave Power	<0.3mW
Microwave Frequency	5.8GHz±75MHz
Detection Area	50% / 100%
Hold-Time	5s / 30s / 1min / 10min
Daylight Threshold	2Lx / 10Lx / 50Lx / Disabled
Stand-By Period	0s / 30s / 20min / +∞
Stand-By Dimming Level	10% / 20% / 30% / 50%
Motion Detection	-0.5 to 1.5m/s
IP Rating	IP20

QPac

Microwave Sensor

Function Overview

On/Off Function (Stand-By Period is 0s)

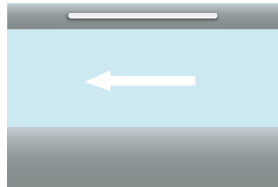

1) If ambient light is at a sufficient level, the light will remain off even if motion is detected.

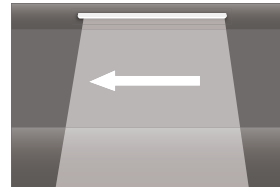

2) If ambient light is not sufficient, the light will switch on when motion is detected by the sensor.

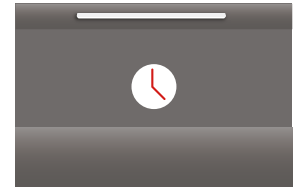

3) After hold-time elapses, the sensor will switch off the light if no motion is detected.

Daylight Threshold Set To 'Disabled'

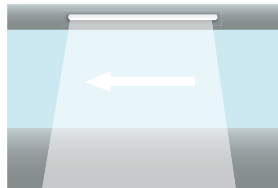

1) If motion is detected, the light will switch on.



2) The sensor keeps the light on for the set hold time after the object leaves the detection area.

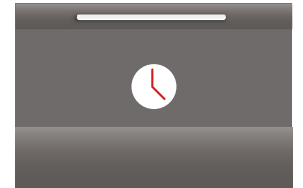

3) After hold-time elapses, the sensor will switch the light back off.

Corridor Function (2 Level Dimming)

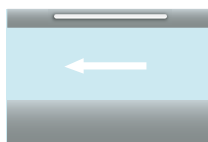

1) If ambient light is at a sufficient level, the light will remain off even if motion is detected.



2) If ambient light is not sufficient, the light will switch on when motion is detected by the sensor.



3) After hold-time elapses, the sensor will switch back to the preset low light level if no motion is detected.



4) After stand-by period elapses, the sensor will switch the light off if no motion is detected.

QPac

Microwave Sensor

Wiring Diagram

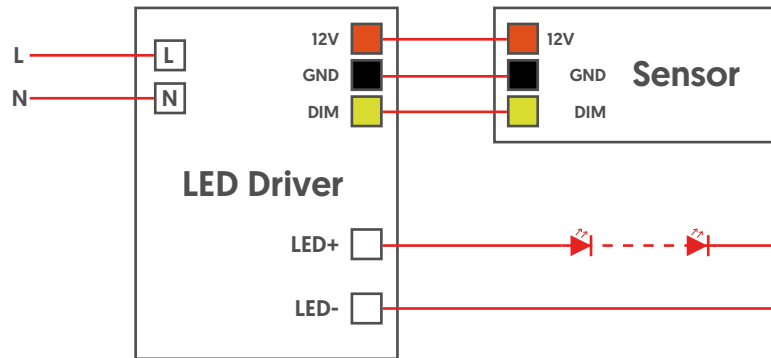

+12V
GND
OUT

Detection Patterns

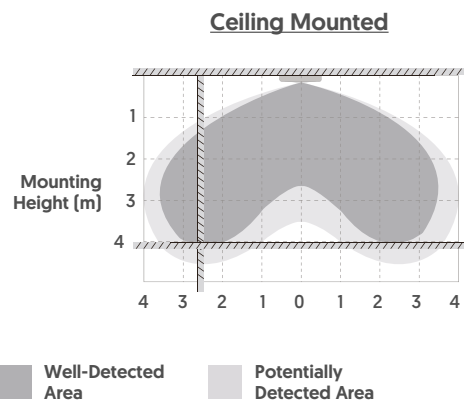

The highest mounting height is ideally 4.5m for optimal detection (see dark grey areas). This figure indicates 100% sensitivity.

QPac

Microwave Sensor

DIP Switch Settings



SWITCH UP

SWITCH DOWN

Stand-By Dimming Level

<input checked="" type="radio"/>	<input checked="" type="radio"/>	10%
<input checked="" type="radio"/>	<input type="radio"/>	20%
<input type="radio"/>	<input checked="" type="radio"/>	30%
<input type="radio"/>	<input type="radio"/>	50%

The dimming level of low output during the stand-by period.

Stand-By Period

<input checked="" type="radio"/>	<input checked="" type="radio"/>	0s
<input checked="" type="radio"/>	<input type="radio"/>	30s
<input type="radio"/>	<input checked="" type="radio"/>	20min
<input type="radio"/>	<input type="radio"/>	+∞

The period that the light stays at lowest output before it completely switches off. When the preset is set to '+∞', the light will always stay at low output when no motion is detected and will not turn off.

Daylight Threshold

<input checked="" type="radio"/>	<input checked="" type="radio"/>	Disable
<input checked="" type="radio"/>	<input type="radio"/>	30s
<input type="radio"/>	<input checked="" type="radio"/>	1min
<input type="radio"/>	<input type="radio"/>	10min

The level of ambient brightness threshold. When ambient brightness is below the preset lux amount, the sensor will operate. If set to 'disabled', the sensor will operate on motion detection regardless of ambient brightness levels.

Hold Time

<input checked="" type="radio"/>	<input checked="" type="radio"/>	5s
<input checked="" type="radio"/>	<input type="radio"/>	30s
<input type="radio"/>	<input checked="" type="radio"/>	1min
<input type="radio"/>	<input type="radio"/>	10min

The period of time that the light stays at 100% brightness once the detected object/person leaves the detection area.

Detection Area

<input checked="" type="radio"/>	100%
<input type="radio"/>	50%

In the specified detection area, movement will trigger the sensor. 100% detection is also known as 'strong sensitivity'.

QPac

Microwave Sensor

Important Notes

- 1) The sensor should only be installed by a qualified electrician.
- 2) Power must be off before any installation, wiring, or changing of DIP switch settings takes place.
- 3) Microwaves cannot penetrate metal. Do not place the sensor within an enclosed metal fitting or half-closed metal fitting. Metal or glass (thicker than 20mm) should not cover the sensor, as this will affect performance.
- 4) Vibration signals may be picked up as moving signals, therefore triggering the sensor. Avoid placing the sensor near objects that vibrate regularly, such as metal equipment, pipes, air conditioning outlets, exhaust vents, smoke exhaust machine ports, shaking fans etc.
- 5) Use for indoor installations only, due to hazards such as rain or wind.
- 6) Wiring must be strictly in accordance to the diagram provided to avoid short circuit.
- 7) Testing should be conducted on sunny days with no lampshade in order to get an accurate lux value reading.