

External



IP66 Ingress Protection



Aluminium Housing



1m Cable Flex

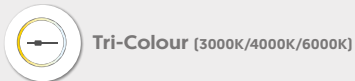

Tri-Colour (3000K/4000K/6000K)

Dimensions

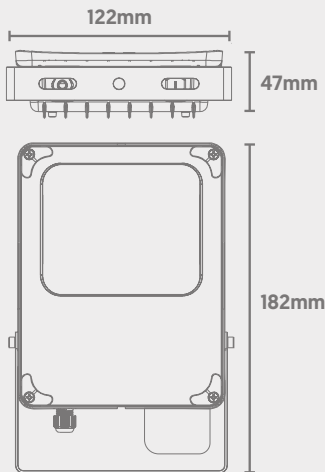

Light Source Energy Rating

Photometric Data

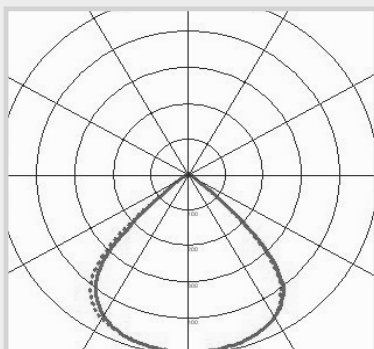

QFlood Residential Tri-Colour Flood Light



CODE: QFLOOD-20TC/D



Tri-Colour Switchable
Behind Access Cap



Power	Efficacy	Output	Kelvin
20W	145Lm/cW	2900Lm	Tri-Colour: 3000K, 4000K or 6000K

Technical

Input Voltage	AC 100-277V
Colour Rendering Index	>80
Beam Spread	120°
Power Factor	>0.93
Operating Temp.	-20 to +45°C
Materials	Aluminium
IP Rating	IP66
Dimmable	DALI 2.0
Cable Flex	1m
Dimensions	182mm x 122mm x 47mm
Weight	0.8kg
MacAdam Step	<3
Lifetime	50,000 hours, L70-B10 (Ta 25 °C)
CE Standards	EN60598-1, EN 60598 2-5, EN62493, EN55015, EN61547, EN61000-3-2, EN61000-3-3, EN62722-1, EN62722-2-1 and EN50581
CE Directives	LVD, EMC, ERP & RoHS