

Downlight



IP67 Ingress Protection



TP(a) Fire Rating



Back-Lit Luminaire



Aluminium Housing

Dimensions

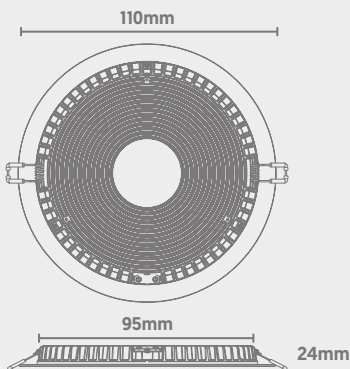

Photometric Data

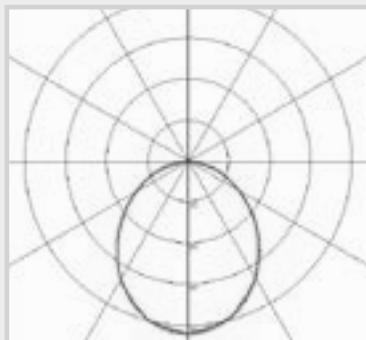

Helios

IP65 Recessed Downlight

QVIS[®]

LIGHTING & SECURITY

CODE: H65-PRO-WS-110TC/LG



Power	Efficacy	Output	Kelvin
6W	150Lm/cW	900Lm	Tri-Colour: 3000K, 4000K & 6000K
8W	150Lm/cW	1200Lm	
9W	150Lm/cW	1350Lm	
10W	150Lm/cW	1500Lm	

Technical

Input Voltage	AC 200-240V
Colour Rendering Index	>85
Beam Spread	90°
Diffuser Type	Low Glare
Power Factor	>0.9
Operating Temp.	-20 to +65°C
Materials	Aluminium & Polycarbonate
IP Rating	IP67
Fire Rating	TP(a)
Dimmable	On Request
Cut Out	95mm
Dimensions	110mm x 24mm
Weight	0.505kg
MacAdam Step	<3
Lifetime	50,000 hours, L90-B10 (Ta 25 °C)
CE Standards	EN60598-1, EN 60598 2-2, EN62493, EN55015, EN61547, EN61000-3-2, EN61000-3-3, EN62722-1, EN62722-2-1 and EN50581
CE Directives	LVD, EMC, ERP & RoHS