

# Surface & Suspended

- Easy-Release Diffuser
- BESA Mounting Points
- Conduit Side Entry
- Metal Housing

## Dimensions

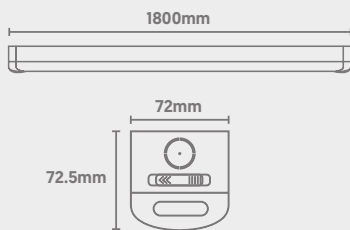

Light Source Energy Rating

## Photometric Data

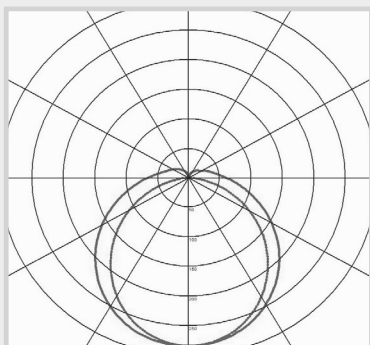

# QPac

## Linear Batten



CODE: QPAC-40-1800NW/MS



Microwave Sensor  
Info on Following Pages

Power	Efficacy	Output	Kelvin
40W	120Lm/cW	4800Lm	4000K

## Technical

Input Voltage	AC 220-240V
Beam Spread	120°
Colour Rendering Index	>80
Power Factor	>0.9
Operating Temp.	-20 to +40°C
Materials	Metal & Polycarbonate
IP Rating	IP20
Dimmable	Microwave Sensor
Dimensions	1800mm x 72.5mm x 72mm
Weight	2.47kg
MacAdam Step	<3
Lifetime	50,000 hours, L70-B10 (Ta 25 °C)
CE Standards	EN60598-1, EN62493, EN55015, EN61547, EN61000-3-2, EN61000-3-3, EN62722-1, EN62722-2-1 and EN50581
CE Directives	LVD, EMC, ERP & RoHS

# QPac

## Microwave Sensor

### Dimensions

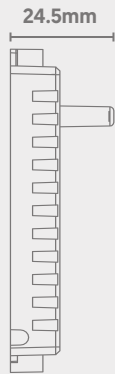
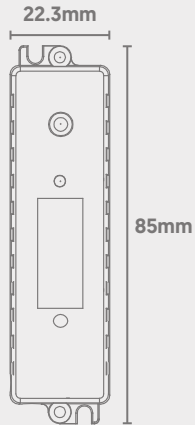

### Main Specifications

<b>Solution Type</b>	Rod Antenna
<b>Input</b>	DC 12V
<b>Dimmable</b>	0-10V
<b>Controls</b>	DIP Switch
<b>Dimensions</b>	85mm x 22.3mm x 24.5mm

### Technical

<b>Operating Voltage</b>	DC 12V
<b>Operating Current</b>	<25mA
<b>Stand-By Power</b>	<0.5W
<b>Mounting Height</b>	2.5m to 4.5m (8.2ft. to 14.76ft.)
<b>Detection Height</b>	4m to 10m (13.12ft. to 32.8ft.)
<b>Microwave Power</b>	<0.3mW
<b>Microwave Frequency</b>	5.8GHz±75MHz
<b>Detection Area</b>	50% / 100%
<b>Hold-Time</b>	5s / 30s / 1min / 10min
<b>Daylight Threshold</b>	2Lx / 10Lx / 50Lx / Disabled
<b>Stand-By Period</b>	0s / 30s / 20min / +∞
<b>Stand-By Dimming Level</b>	10% / 20% / 30% / 50%
<b>Motion Detection</b>	-0.5 to 1.5m/s
<b>IP Rating</b>	IP20

# QPac

## Microwave Sensor

### Function Overview

#### On/Off Function (Stand-By Period is 0s)

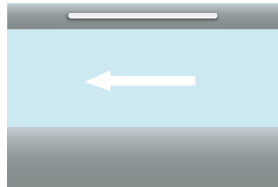

1) If ambient light is at a sufficient level, the light will remain off even if motion is detected.

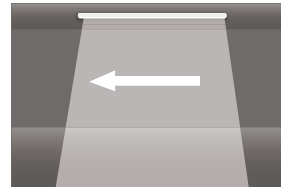

2) If ambient light is not sufficient, the light will switch on when motion is detected by the sensor.

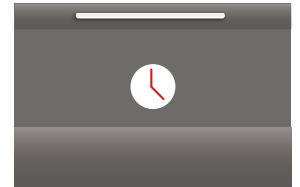

3) After hold-time elapses, the sensor will switch off the light if no motion is detected.

#### Daylight Threshold Set To 'Disabled'

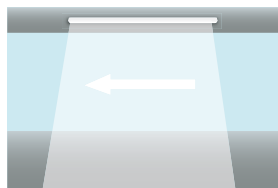

1) If motion is detected, the light will switch on.



2) The sensor keeps the light on for the set hold time after the object leaves the detection area.

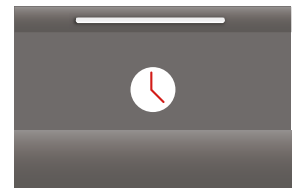

3) After hold-time elapses, the sensor will switch the light back off.

#### Corridor Function (2 Level Dimming)

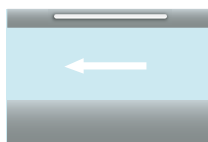

1) If ambient light is at a sufficient level, the light will remain off even if motion is detected.



2) If ambient light is not sufficient, the light will switch on when motion is detected by the sensor.



3) After hold-time elapses, the sensor will switch back to the preset low light level if no motion is detected.



4) After stand-by period elapses, the sensor will switch the light off if no motion is detected.

# QPac

## Microwave Sensor

### Wiring Diagram

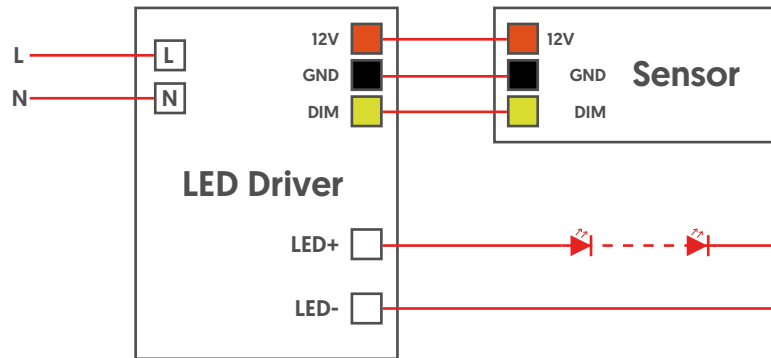

**+12V**  
**GND**  
**OUT**

### Detection Patterns

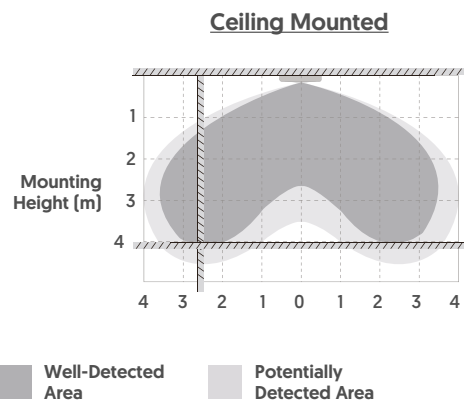

The highest mounting height is ideally 4.5m for optimal detection (see dark grey areas). This figure indicates 100% sensitivity.

# QPac

## Microwave Sensor

### DIP Switch Settings

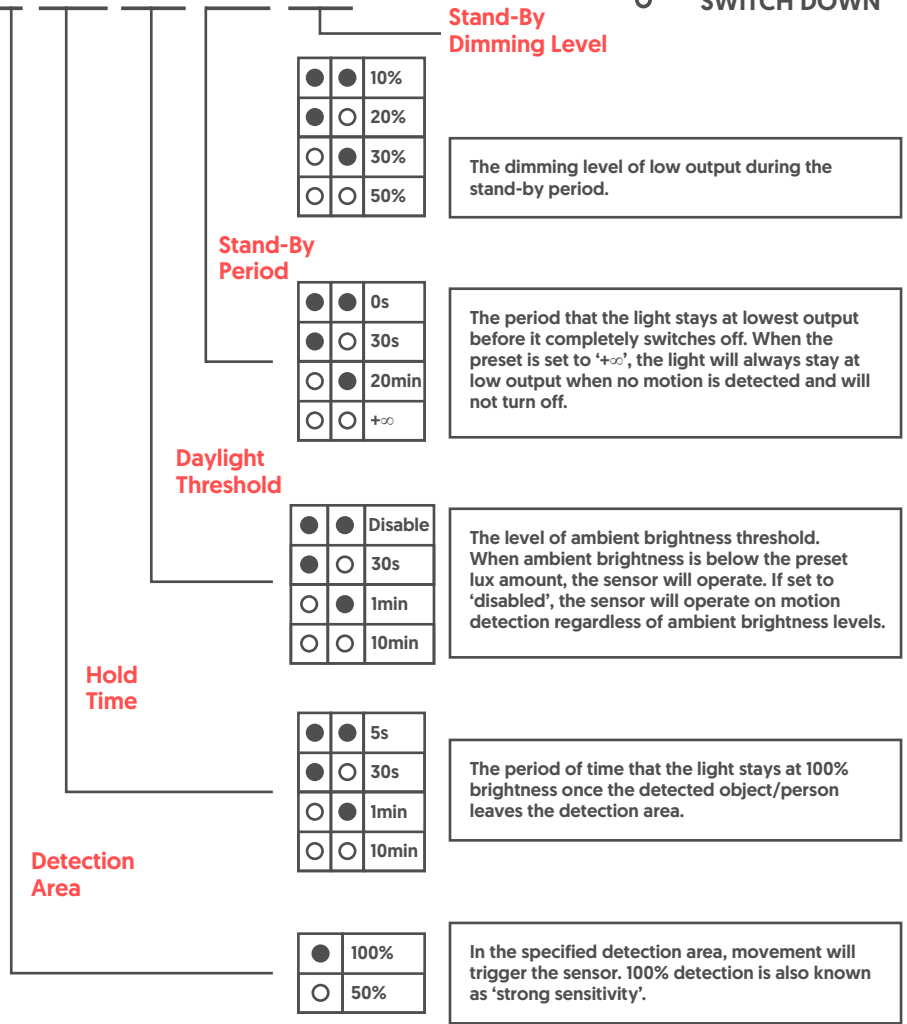
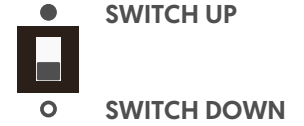

# QPac

## Microwave Sensor

### Important Notes

- 1) The sensor should only be installed by a qualified electrician.
- 2) Power must be off before any installation, wiring, or changing of DIP switch settings takes place.
- 3) Microwaves cannot penetrate metal. Do not place the sensor within an enclosed metal fitting or half-closed metal fitting. Metal or glass (thicker than 20mm) should not cover the sensor, as this will affect performance.
- 4) Vibration signals may be picked up as moving signals, therefore triggering the sensor. Avoid placing the sensor near objects that vibrate regularly, such as metal equipment, pipes, air conditioning outlets, exhaust vents, smoke exhaust machine ports, shaking fans etc.
- 5) Use for indoor installations only, due to hazards such as rain or wind.
- 6) Wiring must be strictly in accordance to the diagram provided to avoid short circuit.
- 7) Testing should be conducted on sunny days with no lampshade in order to get an accurate lux value reading.