

Glow UFO Pro

High Bay

CODE: GU-PRO-240CW

-  IP65 Ingress Protection
-  IK08 Impact Resistance
-  Die-Cast Housing
-  1-10V Dimmable (as Standard)

Dimensions

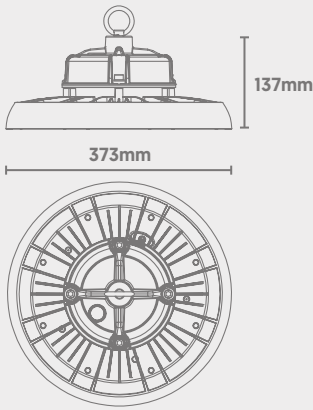

Microwave Sensor
Info on Following Pages



Power	Efficacy	Output	Kelvin
240W	150lm/cW	36000Lm	6000K

Technical

Input Voltage	AC 100-277V
Colour Rendering Index	>80
Beam Spread	90°
Power Factor	>0.95
Operating Temp.	-35 to +50°C
Materials	Die-Cast & Polycarbonate
IP Rating	IP65
IK Rating	IK08
Cable Flex	1.5m
Dimmable	1-10V & Microwave Sensor
Dimensions	373mm x 137mm
Weight	3kg
MacAdam Step	<3
Lifetime	60,000 hours, L70-B10 (Ta 25 °C)
CE Standards	EN60598-1, EN 60598 2-5, EN62493, EN55015, EN61547, EN61000-3-2, EN61000-3-3, EN62722-1, EN62722-2-1 and EN50581
CE Directives	LVD, EMC, ERP & RoHS

Light Source Energy Rating



Photometric Data

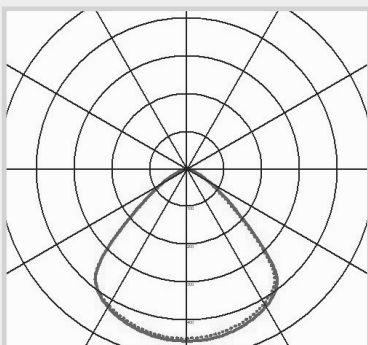

Glow UFO Pro

Plug-In Microwave Sensor

Dimensions

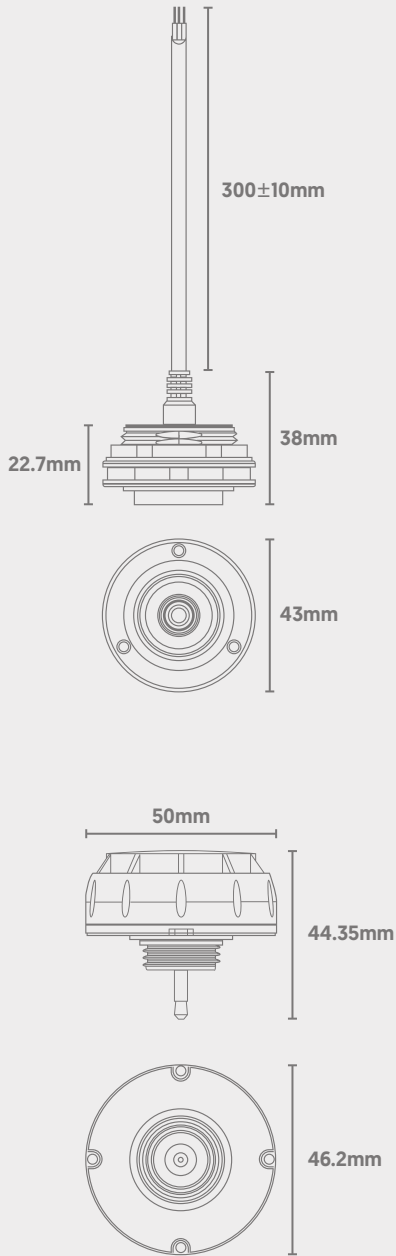

Bending Antenna
(Used in this model)

Planar Antenna
(Used in typical sensors)

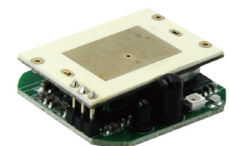
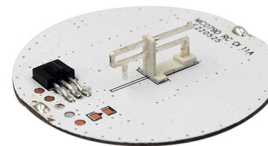

Sensitivity	High gain [6dB+] allows for a larger, more stable detection range.	Low gain [4dB+] may not meet high-sensitivity requirements.
Stability	Low sidelobe design removes false triggering from metal warehouse roofing for better stability.	High sidelobe means it is easy for false triggers to occur, meaning lights may come on even with no motion.
Penetrability	If installed 2m away from a wall, there will be no false triggering from outside motion.	There may be little protection from outside objects triggering false alarms through wall penetration.

Main Specifications

Antenna	Patented High-Gain Antenna [Reduces False Triggers in Metal Warehouses]
Installation	3.5mm Plug
Input & Auxiliary Supply	DC 12V
Dimming Port (0-10V)	2-Step Dimming and 3-Step Dimming Functionality Supported
Mounting Height	Up to 12m
Control	via Remote Control

Glow UFO Pro

Plug-In Microwave Sensor

Technical

Input	Input Voltage	DC 11-13V
	Operating Voltage	DC 12V
	Operating Current	<30mA
	Ripple Voltage	<100mVp-p
	0-10V Dimming Signal	Supported
Sensor Parameters	Operating Frequency	5.8 GHz \pm 75 MHz; ISM wave.
	Transmission Power	3mW Maximum
	Detection Area	100% / 75% / 50% / 25%
	Hold Time	5s / 30s / 1min / 3min / 5min / 10min / 20min / 30min
	Stand-By Period	0s / 10s / 1min / 3min / 5min / 10min / 30min / $+\infty$
	Daylight Sensor	5Lx / 15Lx / 30Lx / 50Lx / 100Lx / 150Lx / Disabled
	Stand-By Dim Level	10% [1.4-1.6V] 20% [1.9-2.1V]; 30% [2.9-3.1V] 50% [4.9-5.1V]
	Detection Radius [100% Detection Area]	Ceiling Mounting (Height: 10m): 0.3m/S \geq 4m; 1m/S \geq 3m
	Mounting Height	10m [12m Maximum]
	3dB Field Angle	90°@Xz field 130°@Yz field
Operating Environment	Operating Temperature	-25 to +70°C
	Storage Temperature	-40 to +80°C
	Storage Humidity	10% to 95% (Non-Condensing)
Certification Standards	Certification	CE
	Environmental Requirements	Compliant to RoHS
	IP Rating	IP65
Others	Wiring Method	3.5mm Plug
	Weight	0.643kg

Glow UFO Pro

Plug-In Microwave Sensor

Function Overview

On/Off Function (Stand-By Period is 0s)

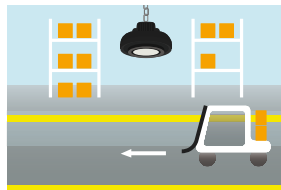

1) If ambient light is at a sufficient level, the light will remain off even if motion is detected.

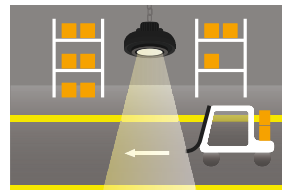

2) If ambient light is not sufficient, the light will switch on when motion is detected by the sensor.

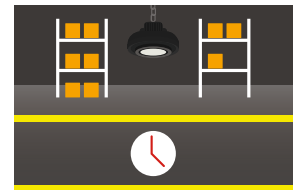

3) After hold-time elapses, the sensor will switch off the light if no motion is detected.

2-Step Dimming Function (Stand-By Period is +∞)

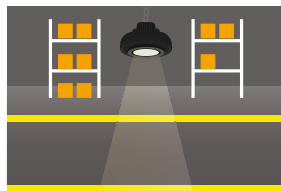

1) If no motion is detected, the light output will stay at a low level.

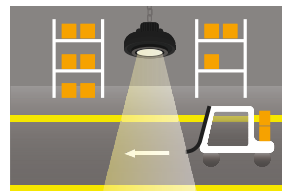

2) If motion is detected, the light will switch to 100% brightness.

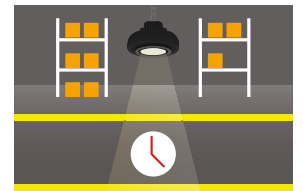

3) After hold-time elapses, the sensor will switch back to the preset low light level if no motion is detected.

3-Step Dimming Function (Stand-By Period is 10s/1min/3min/5min/10min/30min)

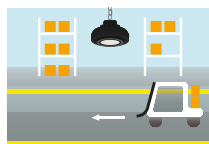

1) If ambient light is at a sufficient level, the light will remain off even if motion is detected.

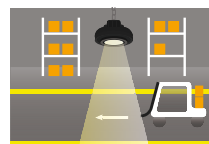

2) If ambient light is not sufficient, the light will switch on when motion is detected by the sensor.



3) After hold-time elapses, the sensor will switch back to the preset low light level if no motion is detected.

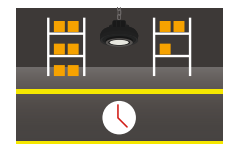

4) After stand-by period elapses, the sensor will switch the light off if no motion is detected.

Glow UFO Pro

Plug-In Microwave Sensor

Wiring Diagram*

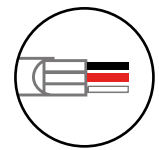
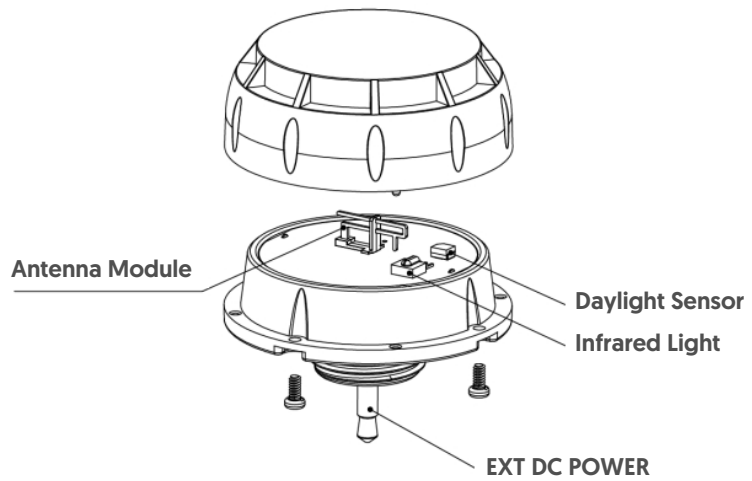

Black GND
Red DC 12V
White 0-10V

Glow UFO Pro

Plug-In Microwave Sensor



Radiation Patterns

Mounting Height: 9m

Detection Area:
100/75/50/25%

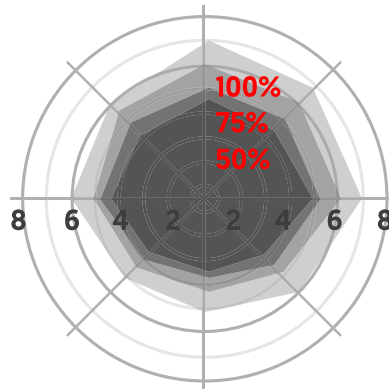

Normal Movement
(Speed: 1m/s)

Mounting Height: 9m

Detection Area:
100/75/50/25%

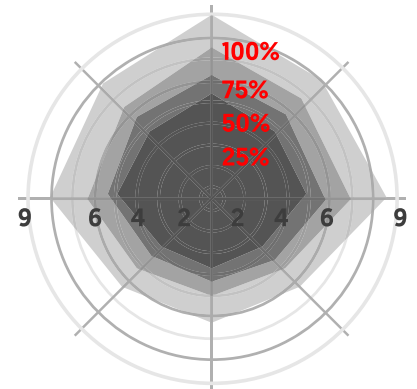

Slow Movement
(Speed: 0.3m/s)

Mounting Height: 12m

Detection Area:
100/75/50%

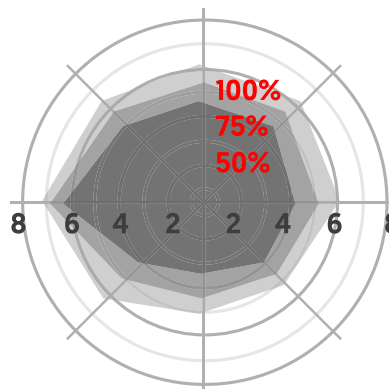

Normal Movement
(Speed: 1m/s)

Mounting Height: 12m

Detection Area:
100/75/50%

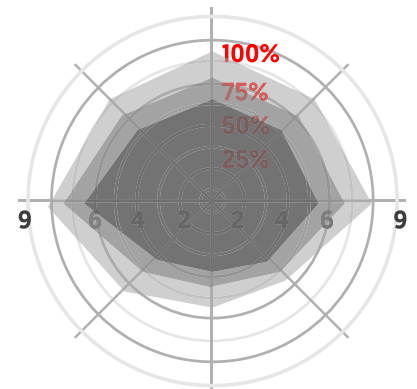

Slow Movement
(Speed: 0.3m/s)

Glow UFO Pro

Plug-In Microwave Sensor

Remote Control

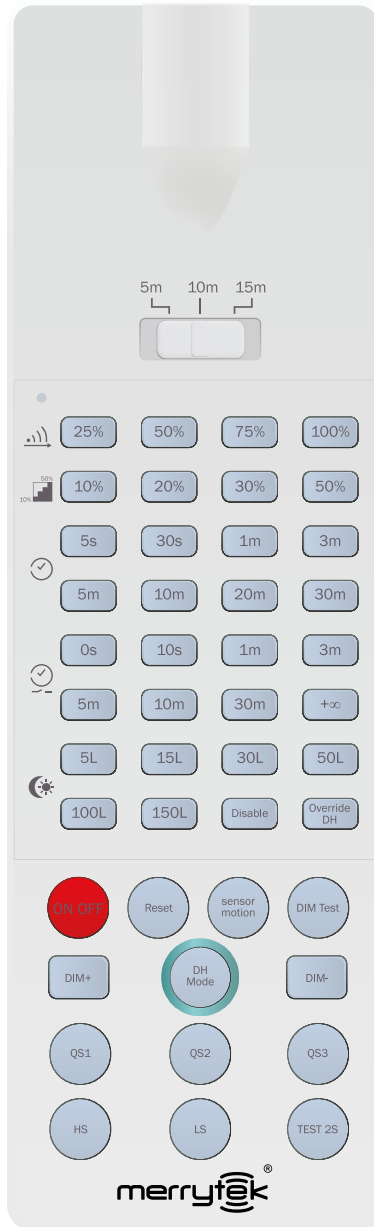

Remote distance toggle switch
(5m / 10m / 15m)



Set detection area
(25% / 50% / 75% / 100%)



Set stand-by dim level
(10% / 20% / 30% / 50%)



Set hold time
(5s / 30s / 1min / 3min / 5min / 10min / 20min / 30min)



Set stand-by period
(5s / 10s / 1min / 3min / 5min / 10min / 20min / 30min / +∞)



Set daylight sensor threshold
(5Lx / 15Lx / 30Lx / 50Lx / 100Lx / 150Lx / Disabled)



This button sets the sensor to constant on/off mode - meaning the sensor will not operate



Reset all parameters to factory settings



Use this button to set light back to sensor mode instead of on/off



Test mode at 100% detection area, 5s hold-time, 10% stand-by dim level, 0s stand-by period, daylight sensor disabled



Scene settings (see below)



***Override DH*, 'DH Mode' and any associated functions are not applicable to this sensor model. Also not applicable are 'DIM Test' and the High Sensitivity (HS) and Low Sensitivity (LS) buttons.**

Scene Settings

Scene	Detection Area	Hold Time	Stand-by Period	Stand-by Dim Level	Daylight Sensor	Sensitivity Model
QS1	100%	5min	0s	10%	30Lx	High Sensitivity
QS2	100%	10min	0s	10%	Disable	High Sensitivity
QS3	100%	20min	0s	10%	Disable	High Sensitivity

Glow UFO Pro

Plug-In Microwave Sensor

Initialisation

1) After switching on, the sensor will automatically be at 100% brightness. After 10 seconds, the light will dim to a low level. During the initialisation process, the sensor will not detect movement.

Factory Settings

- **Detection Area: 100%**
- **Hold Time: 5s**
- **Stand-By Period: 0s**
- **Daylight Sensor: Disabled**

Important Notes

- 1)** The sensor should only be installed by a qualified electrician.
- 2)** Power must be off before any installation, wiring, or changing of DIP switch settings takes place.
- 3)** Microwaves cannot penetrate metal. Do not place the sensor within an enclosed metal fitting or half-closed metal fitting. Metal or glass should not cover the sensor, as this will affect performance. If the antenna needs to pass through a metal plate, please ensure that the top of the sensor is close to the plate.
- 4)** The distance between the sensor and any other sensors should be greater than 3m. Keep the sensor away from switches, routers and other wireless devices that may interfere, in order to avoid radio interference. The antenna surface of the module should not directly face the AC input or DC output, as low or high frequency signals may affect normal operation of the antenna.
- 5)** Vibration signals may be picked up as moving signals, therefore triggering the sensor. Avoid placing the sensor near objects that vibrate regularly, such as metal equipment, pipes, air conditioning outlets, exhaust vents, smoke exhaust machine ports, shaking fans etc.
- 6)** The sensor is built for indoor use only. Wind, rain and moving objects may cause false triggering, and performance can be affected by water.
- 7)** Installation within a metal fitting, metal reflective surface or inside a narrow enclosure may also cause false triggering (reduce the sensitivity, or avoid installing in these environments.)
- 8)** The light sensitivity threshold is a daylight environment, with no shadow and ambient light diffusion reflections. Ambient lux levels could be compatible to various environments (weather, climate, time-of-day).
- 9)** Dimming performance may differ depending on the 1-10V driver used.
- 10)** Sensitivity range is relative to moving speed of objects, the size of moving objects, mounting height, mounting angle, working environments, reflecting materials etc.
- 11)** This product should be used with a voltage-stabilised DC power supply with stable input voltage and low ripple factor (ripple factor below 100mV; load current greater than 25mA).