

## Glow UFO 170 High Bay

CODE: GU-170-200NW/MS

-  IP65 Ingress Protection
-  IK08 Impact Resistance
-  170 High LED Efficacy
-  1-10V Dimmable (as Standard)

### Dimensions

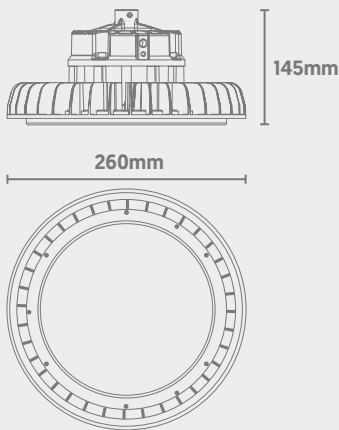

Microwave Sensor  
Info on Following Pages



| Power | Efficacy | Output  | Kelvin |
|-------|----------|---------|--------|
| 200W  | 170Lm/cW | 34000Lm | 4000K  |

### Technical

|                        |   |
|------------------------|---|
| Input Voltage          | AC 100-277V   |
| Colour Rendering Index | >70   |
| Beam Spread            | 110°  |
| Power Factor           | >0.9  |
| Operating Temp.        | -30 to +50°C  |
| Materials              | Aluminium & Tempered Glass  |
| IP Rating              | IP65  |
| IK Rating              | IK08  |
| Cable Flex             | 1.5m  |
| Dimmable               | 1-10V & Microwave Sensor  |
| Dimensions             | 260mm x 145mm   |
| Weight                 | 1.9kg   |
| MacAdam Step           | <3  |
| Lifetime               | 50,000 hours, L90-B10<br>(Ta 25 °C)   |
| CE Standards           | EN60598-1, EN 60598 2-5, EN62493,<br>EN55015, EN61547, EN61000-3-2,<br>EN61000-3-3, EN62722-1, EN62722-2-1<br>and EN50581 |
| CE Directives          | LVD, EMC, ERP & RoHS  |

### Light Source Energy Rating

### Photometric Data

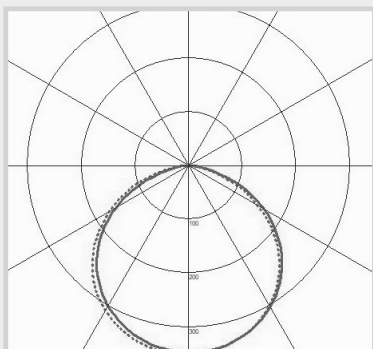

# Glow UFO 170

## Microwave Sensor

### Dimensions

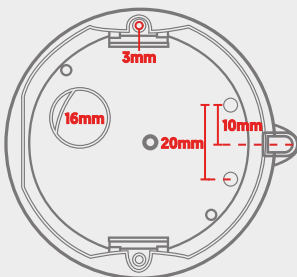
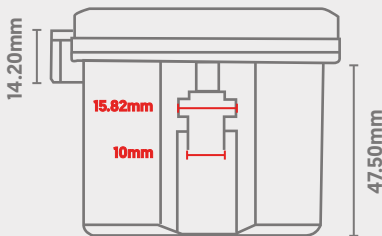
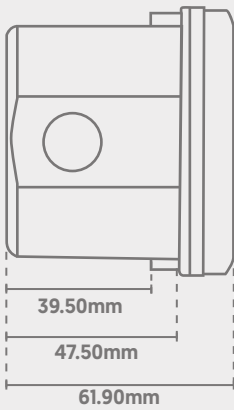
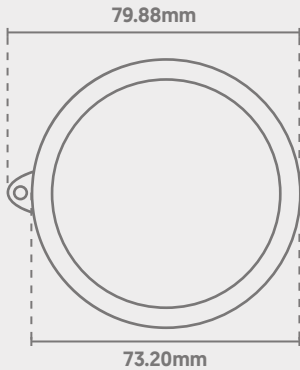

### Main Specifications

|                      |   |
|----------------------|---|
| Operating Voltage    | AC 120-277V   |
| Antenna              | Patented Microwave Antenna  |
| Mounting Height      | Up to 15m   |
| Sensitivity          | High and Low Sensitivity Support<br>(for Metal Ceilings/Metal Reflector Environments) |
| Driver Compatibility | Works with 1-10V Dimmable Drivers for 2-Step or 3-Step Dimming                        |
| Control              | via Remote Control  |

### Technical

|        |                              |  |
|--------|------------------------------|--|
| Input  | Operating Voltage Range      | AC 108-305V; 50/60Hz   |
|        | DC Input Range               | Not Applicable To This Model                                 |
|        | Rated Voltage                | AC 120-277V; 60Hz  |
|        | No-Load Power                | Not Applicable To This Model                                 |
|        | Stand-By Power               | <1W  |
|        | Surge Test                   | L-N: 1kV   |
| Output | Working Mode                 | On/Off Function; 1-10V Step-Dim                              |
|        | Type of Load                 | Inductive or Resistive                                       |
|        | Load Capacity                | AC 120V; 4A / AC 220-277V: 3A                                |
|        | Current of Load              | Not Applicable To This Model                                 |
|        | Maximum Surge Capacity (50A) | 50% iPeak, tWidth = 500uS;<br>AC 230V Full Load & Cold Start |
|        | Maximum Surge Capacity (80A) | 50% iPeak, tWidth = 200uS;<br>AC 230V Full Load & Cold Start |

# Glow UFO 170

## Microwave Sensor

### Technical

|                         |                            |  |
|-------------------------|----------------------------|--|
| Dim Interface           | 1-10V Dimming              | <50mA (Non-Constant Source);<br>10% [1.4-1.6V]; 20% [1.9-2.1V];<br>30% [2.9-3.1V]; 50% [4.9-5.1V];   |
|                         | Synchronous Control        | Not Applicable To This Model   |
|                         | High/Low Level             | Not Applicable To This Model   |
|                         | PWM Control                | Not Applicable To This Model   |
| Sensor Parameters       | Operating Frequency        | 5.8 GHz $\pm$ 75 MHz; ISM Band   |
|                         | Transmission Power         | 0.5mW Max.   |
|                         | Hold Time                  | 5s / 30s / 1min / 3min / 5min / 10min /<br>30min / $+\infty$   |
|                         | Stand-By Dim Level         | 10% / 20% / 30% / 50%  |
|                         | Stand-By Period            | 0s / 10s / 1min / 3min / 5min / 10min /<br>30min / $+\infty$   |
|                         | Detection Area             | 25% / 50% / 75% / 100%   |
|                         | Daylight Sensor            | 5Lx / 15Lx / 30Lx / 50Lx / 100Lx / 150Lx<br>/ Disabled (Ambient Light Diffusion)   |
|                         | Detection Radius           | See Page 5 (Radiation Patterns)  |
|                         | Mounting Height            | Up to 15m  |
|                         | Detection Angle            | 150° (Wall Mounting),<br>360° (Ceiling Mounting)   |
| Operating Environment   | Operating Temperature      | -35°C to +55°C   |
|                         | Storage Temperature        | -40°C to +80°C   |
|                         | Storage Humidity           | 10% to 95% (Non-Condensing)  |
|                         | Detection Angle            | 150° (Wall Mounting),<br>360° (Ceiling Mounting)   |
| Certification Standards | Safety Standards           | IEC60669-2-1, IEC60669-1<br>AS/NZS 60669.1, AS/NZS 60669.2.1<br>UL60730-1  |
|                         | EMC Standards              | EN55015, EN61000-3-2, EN61000-3-3,<br>EN61547 AS/NZS CISPR 15, AS/NZS 4268<br>FCC Part 15C, Part 15B<br>EN 60950-1, EN301489-1, EN 201489-3,<br>EN300440 |
|                         | Environmental Requirements | Compliant to RoHS  |
|                         | Certification              | cULus, CE, SAA, FCC, RED   |
| Others                  | Wiring*                    | H05RR-F,5*18AWG;<br>Exposed Line Length: 810-830mm   |
|                         | Wiring Colours*            | Sheath: Black;<br>Core: Blue, Brown, Red, Purple, Gray   |
|                         | IP Rating                  | IP65   |
|                         | Protection Class           | Class II   |
|                         | Dimensions                 | 72mm x 59mm  |
|                         | Net Weight                 | 0.225kg  |

\* Wiring profiles are applicable to Europe and Australia only.

# Glow UFO 170

## Microwave Sensor

### Function Overview

#### On/Off Function (Stand-By Period is 0s)

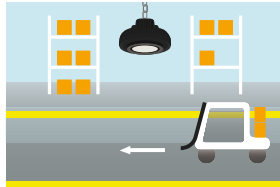

1) If ambient light is at a sufficient level, the light will remain off even if motion is detected.

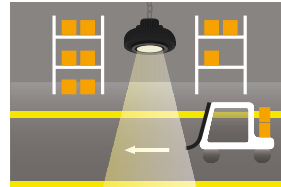

2) If ambient light is not sufficient, the light will switch on when motion is detected by the sensor.

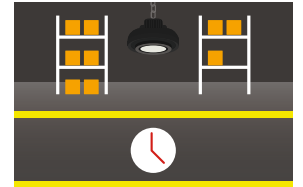

3) After hold-time elapses, the sensor will switch off the light if no motion is detected.

#### 2-Step Dimming Function (Stand-By Period is +∞)

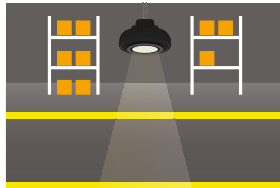

1) If no motion is detected, the light output will stay at a low level.

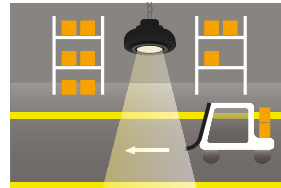

2) If motion is detected, the light will switch to 100% brightness.

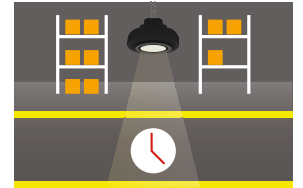

3) After hold-time elapses, the sensor will switch back to the preset low light level if no motion is detected.

#### 3-Step Dimming Function (Stand-By Period is 10s/1min/3min/5min/10min/30min)

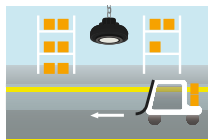

1) If ambient light is at a sufficient level, the light will remain off even if motion is detected.



2) If ambient light is not sufficient, the light will switch on when motion is detected by the sensor.

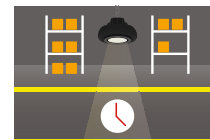

3) After hold-time elapses, the sensor will switch back to the preset low light level if no motion is detected.

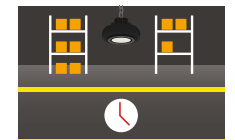

4) After stand-by period elapses, the sensor will switch the light off if no motion is detected.

# Glow UFO 170

Microwave Sensor

### Wiring Diagram\*

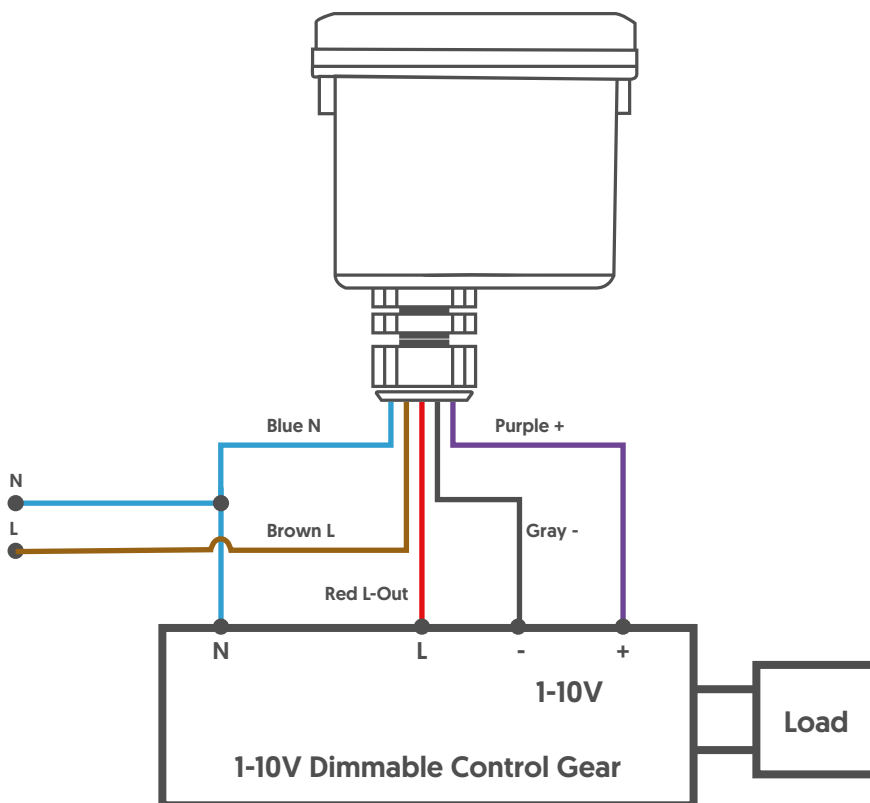

\* Wiring profiles are applicable to Europe and Australia only.

### Function Diagram

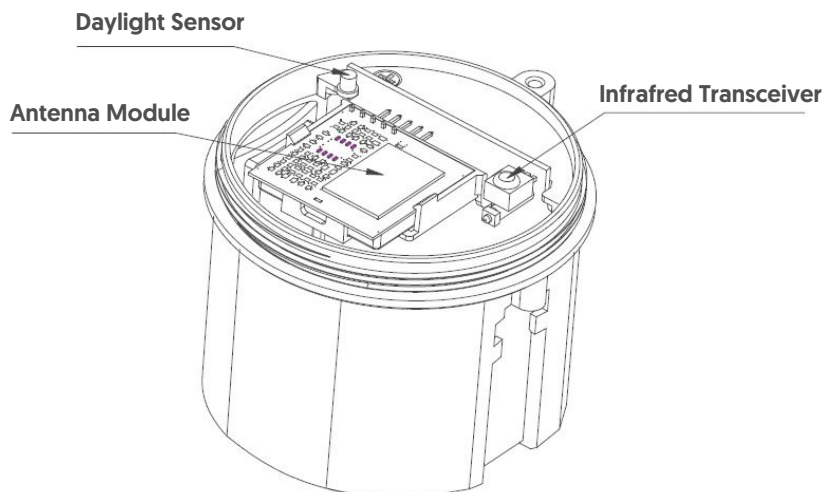

# Glow UFO 170

## Microwave Sensor

### Radiation Patterns

#### Ceiling Mounted

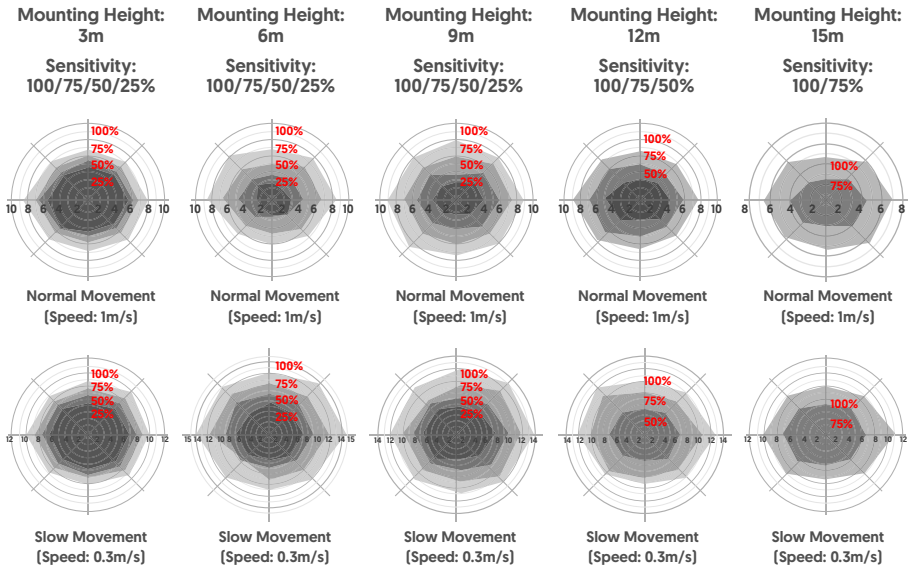

Note: Only 100%/75%/50% detection sensitivity is feasible when installed at 10m or 15m mounting height, as 25% will not detect motion.

#### Wall Mounted

Mounting Height: 2m  
Sensitivity: 100/75/50/25%

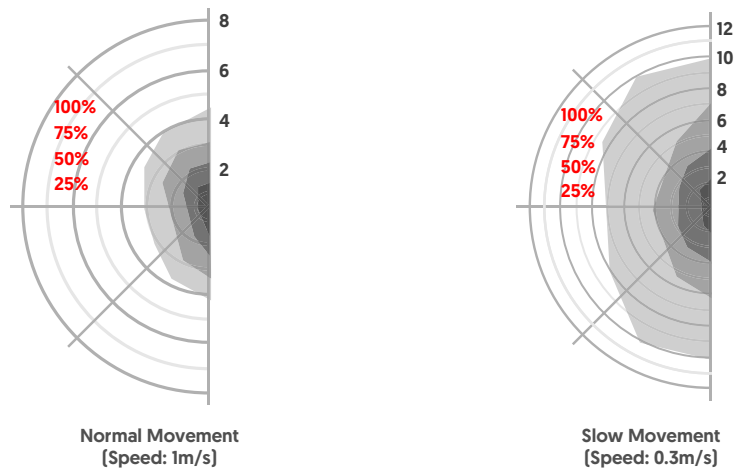

# Glow UFO 170

## Microwave Sensor

### Remote Control

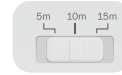
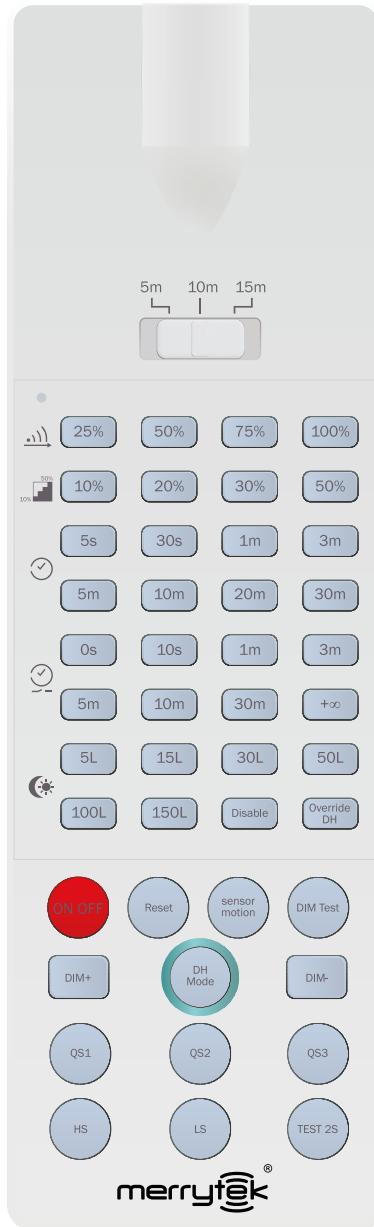

**Remote distance toggle switch**  
(5m / 10m / 15m)



**Set detection area**  
(25% / 50% / 75% / 100%)



**Set stand-by dim level**  
(10% / 20% / 30% / 50%)



**Set hold time**  
(5s / 30s / 1min / 3min / 5min / 10min / 20min / 30min)



**Set stand-by period**  
(5s / 10s / 1min / 3min / 5min / 10min / 20min / 30min / +∞)



**Set daylight sensor threshold**  
(5Lx / 15Lx / 30Lx / 50Lx / 100Lx / 150Lx / Disabled)



This button sets the sensor to constant on/off mode - meaning the sensor will not operate



Reset all parameters to factory settings



Use this button to set light back to sensor mode instead of on/off



A 2 second test to show whether the 1-10V ports are connected



Scene settings (see below)



High sensitivity / low sensitivity



Test mode at 100% detection area, 5s hold-time, 10% stand-by dim level, 0s stand-by period, daylight sensor disabled



'Override DH', 'DH Mode' and any associated functions are not applicable to this sensor model

### Scene Settings

| Scene | Detection Area | Hold Time | Stand-by Period | Stand-by Dim Level | Daylight Sensor | Sensitivity Model |
|-------|----------------|-----------|-----------------|--------------------|-----------------|-------------------|
| QS1   | 100%           | 5min      | 10min           | 10%                | 30Lx            | High Sensitivity  |
| QS2   | 100%           | 10min     | 30min           | 10%                | Disable         | High Sensitivity  |
| QS3   | 100%           | 20min     | 30min           | 10%                | Disable         | High Sensitivity  |

# Glow UFO 170

## Microwave Sensor

### Initialisation

#### 1) On/off function or 3-step dimming function:

After switching on, the sensor will automatically be at 100% brightness. After 10 seconds, the light will turn off. During the initialisation process, the sensor will not detect movement.

#### 2) 2-step dimming function:

After switching on, the sensor will automatically be at 100% brightness. After 10 seconds, the light will dim to a low level [set by stand-by dim level]. During the initialisation process, the sensor will not detect movement.

### Factory Settings

- Detection Area: 100%
- Hold Time: 5s
- Stand-By Period: 0s
- Stand-By Dim Level: 10%
- Daylight Sensor: Disabled

### Override Function

Switch power on and off 3 times to override the sensor functionality.  
Switch on and off once to recover the sensor functionality.

### Important Notes

- 1) The sensor should only be installed by a qualified electrician.
- 2) If the sensor is installed within a plastic or glass shade, sensitivity will reduce. Reduction can be 20% for every 3mm of housing thickness.
- 3) Power must be off before any installation, wiring, or changing of DIP switch settings takes place.
- 4) Dimming performance may differ depending on the 1-10V driver used.
- 5) The light sensitivity threshold is a daylight environment, with no shadow and ambient light diffusion reflections. Ambient lux levels could be compatible to various environments [weather, climate, time-of-day].
- 6) Parameters may need adjusting in certain environments. Be sure to carefully read the below notes before installing or adjusting.
- 7) The sensor is built for indoor use only. Wind, rain and moving objects may cause false triggering, and performance can be affected by water.
- 8) The sensor should always be at least 3m distance from other sensors
- 9) Do not place the sensor too close to high-density objects or materials, such as metals, glass, concrete, walls etc. Placing the sensor too close may cause false triggering. Installation within a metal fitting, metal reflective surface or inside a narrow enclosure may also cause false triggering [reduce the sensitivity, or avoid installing in these environments.]
- 10) To avoid false triggers, please ensure that there are no moving signals around the sensor. This may include fans, DC, motors, sewage pipes or air outlets.