

Glow UFO 170

High Bay

CODE: GU-170-100NW/ME



-  IP65 Ingress Protection
-  IK08 Impact Resistance
-  170 High LED Efficacy
-  1-10V Dimmable (as Standard)

Dimensions

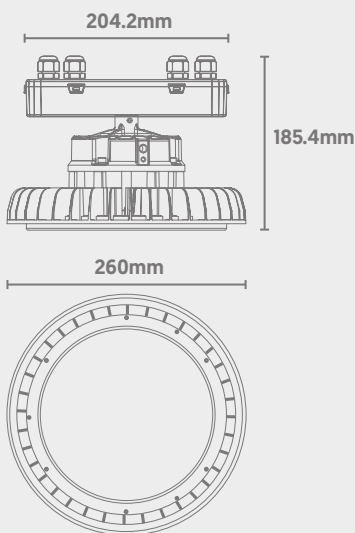

Power	Efficacy	Output	Kelvin
100W [Emergency 5W]	170Lm/cW	17000Lm [Emergency 850Lm]	4000K

Technical

Input Voltage	AC 100-277V
Colour Rendering Index	>70
Beam Spread	110°
Power Factor	>0.9
Operating Temp.	-30 to +50°C
Materials	Aluminium & Tempered Glass
IP Rating	IP65
IK Rating	IK08
Cable Flex	1.5m
Dimmable	1-10V & Microwave Sensor
Dimensions	260mm x 185.4mm
Weight	2.7kg
MacAdam Step	<3
Emergency Output	3 Hours [5W]
Lifetime	50,000 hours, L90-B10 [Ta 25 °C]
CE Standards	EN60598-1, EN 60598 2-5, EN62493, EN55015, EN61547, EN61000-3-2, EN61000-3-3, EN62722-1, EN62722-2-1 and EN50581
CE Directives	LVD, EMC, ERP & RoHS

Light Source Energy Rating

Photometric Data

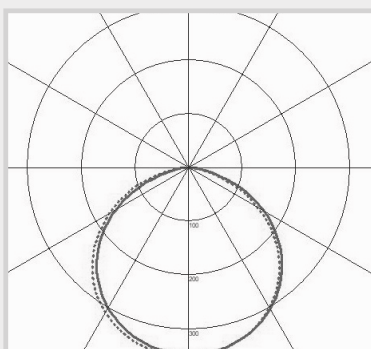

Glow UFO 170

Microwave Sensor

Dimensions

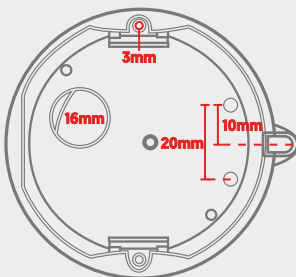
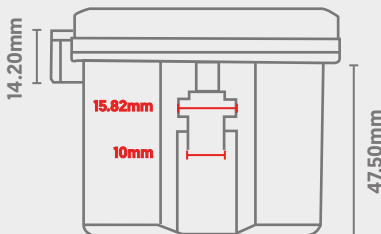
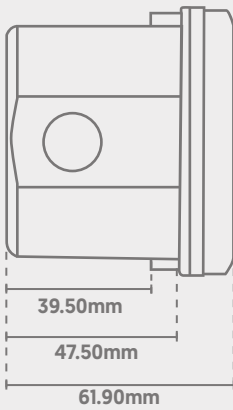
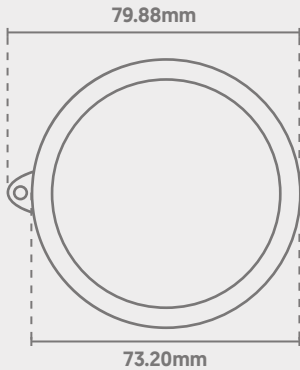

Main Specifications

Operating Voltage	AC 120-277V
Antenna	Patented Microwave Antenna
Mounting Height	Up to 15m
Sensitivity	High and Low Sensitivity Support (for Metal Ceilings/Metal Reflector Environments)
Driver Compatibility	Works with 1-10V Dimmable Drivers for 2-Step or 3-Step Dimming
Control	via Remote Control

Technical

Input	Operating Voltage Range	AC 108-305V; 50/60Hz
	DC Input Range	Not Applicable To This Model
	Rated Voltage	AC 120-277V; 60Hz
	No-Load Power	Not Applicable To This Model
	Stand-By Power	<1W
	Surge Test	L-N: 1kV
	Output	Working Mode
Type of Load		Inductive or Resistive
Load Capacity		AC 120V; 4A / AC 220-277V: 3A
Current of Load		Not Applicable To This Model
Maximum Surge Capacity (50A)		50% iPeak, tWidth = 500uS; AC 230V Full Load & Cold Start
Maximum Surge Capacity (80A)		50% iPeak, tWidth = 200uS; AC 230V Full Load & Cold Start

Glow UFO 170

Microwave Sensor

Technical

Dim Interface	1-10V Dimming	<50mA (Non-Constant Source); 10% [1.4-1.6V]; 20% [1.9-2.1V]; 30% [2.9-3.1V]; 50% [4.9-5.1V];
	Synchronous Control	Not Applicable To This Model
	High/Low Level	Not Applicable To This Model
	PWM Control	Not Applicable To This Model
Sensor Parameters	Operating Frequency	5.8 GHz \pm 75 MHz; ISM Band
	Transmission Power	0.5mW Max.
	Hold Time	5s / 30s / 1min / 3min / 5min / 10min / 30min / $+\infty$
	Stand-By Dim Level	10% / 20% / 30% / 50%
	Stand-By Period	0s / 10s / 1min / 3min / 5min / 10min / 30min / $+\infty$
	Detection Area	25% / 50% / 75% / 100%
	Daylight Sensor	5Lx / 15Lx / 30Lx / 50Lx / 100Lx / 150Lx / Disabled (Ambient Light Diffusion)
	Detection Radius	See Page 5 (Radiation Patterns)
	Mounting Height	Up to 15m
	Detection Angle	150° (Wall Mounting), 360° (Ceiling Mounting)
Operating Environment	Operating Temperature	-35°C to +55°C
	Storage Temperature	-40°C to +80°C
	Storage Humidity	10% to 95% (Non-Condensing)
	Detection Angle	150° (Wall Mounting), 360° (Ceiling Mounting)
Certification Standards	Safety Standards	IEC60669-2-1, IEC60669-1 AS/NZS 60669.1, AS/NZS 60669.2.1 UL60730-1
	EMC Standards	EN55015, EN61000-3-2, EN61000-3-3, EN61547 AS/NZS CISPR 15, AS/NZS 4268 FCC Part 15C, Part 15B EN 60950-1, EN301489-1, EN 201489-3, EN300440
	Environmental Requirements	Compliant to RoHS
	Certification	cULus, CE, SAA, FCC, RED
Others	Wiring*	H05RR-F,5*18AWG; Exposed Line Length: 810-830mm
	Wiring Colours*	Sheath: Black; Core: Blue, Brown, Red, Purple, Gray
	IP Rating	IP65
	Protection Class	Class II
	Dimensions	72mm x 59mm
	Net Weight	0.225kg

* Wiring profiles are applicable to Europe and Australia only.

Glow UFO 170

Microwave Sensor

Function Overview

On/Off Function (Stand-By Period is 0s)

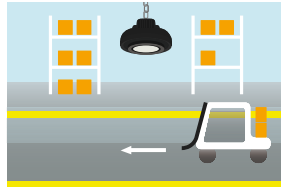

1) If ambient light is at a sufficient level, the light will remain off even if motion is detected.

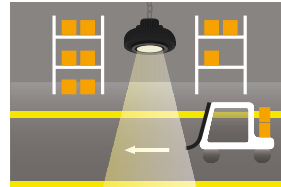

2) If ambient light is not sufficient, the light will switch on when motion is detected by the sensor.

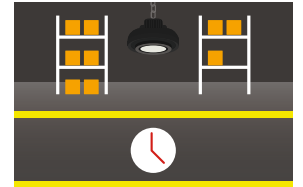

3) After hold-time elapses, the sensor will switch off the light if no motion is detected.

2-Step Dimming Function (Stand-By Period is +∞)

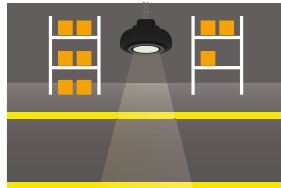

1) If no motion is detected, the light output will stay at a low level.

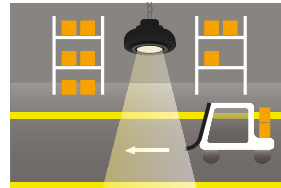

2) If motion is detected, the light will switch to 100% brightness.

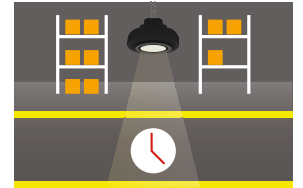

3) After hold-time elapses, the sensor will switch back to the preset low light level if no motion is detected.

3-Step Dimming Function (Stand-By Period is 10s/1min/3min/5min/10min/30min)



1) If ambient light is at a sufficient level, the light will remain off even if motion is detected.

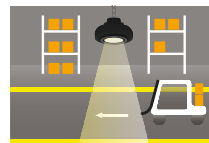

2) If ambient light is not sufficient, the light will switch on when motion is detected by the sensor.

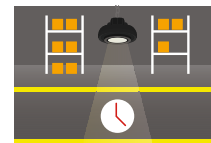

3) After hold-time elapses, the sensor will switch back to the preset low light level if no motion is detected.

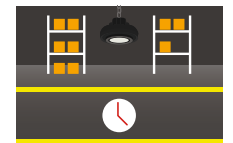

4) After stand-by period elapses, the sensor will switch the light off if no motion is detected.

Glow UFO 170

Microwave Sensor

Wiring Diagram*

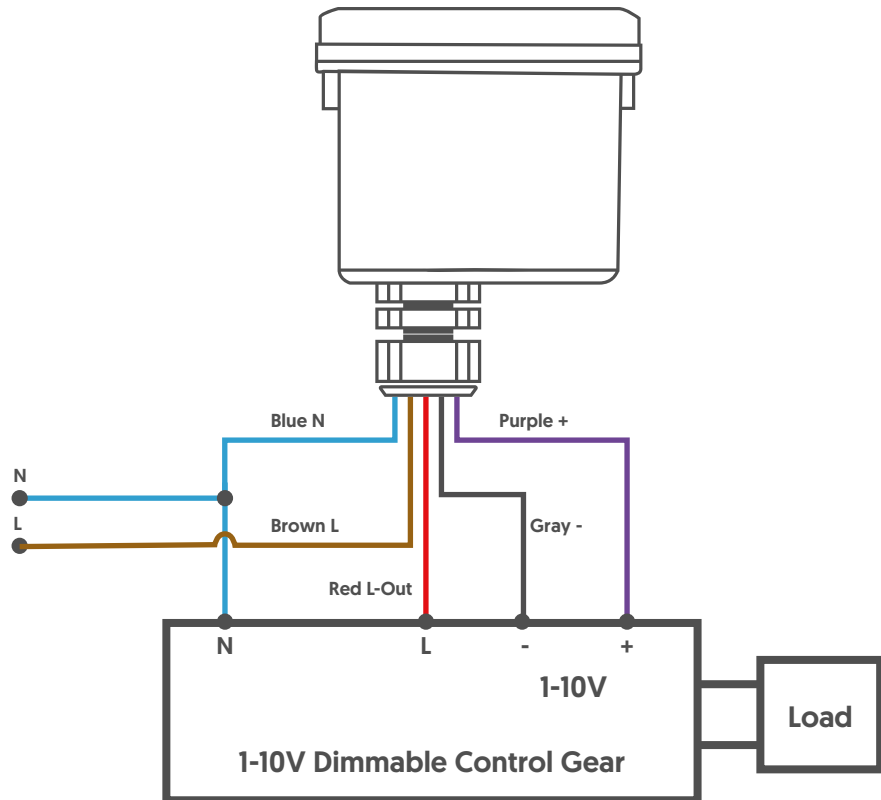

* Wiring profiles are applicable to Europe and Australia only.

Function Diagram

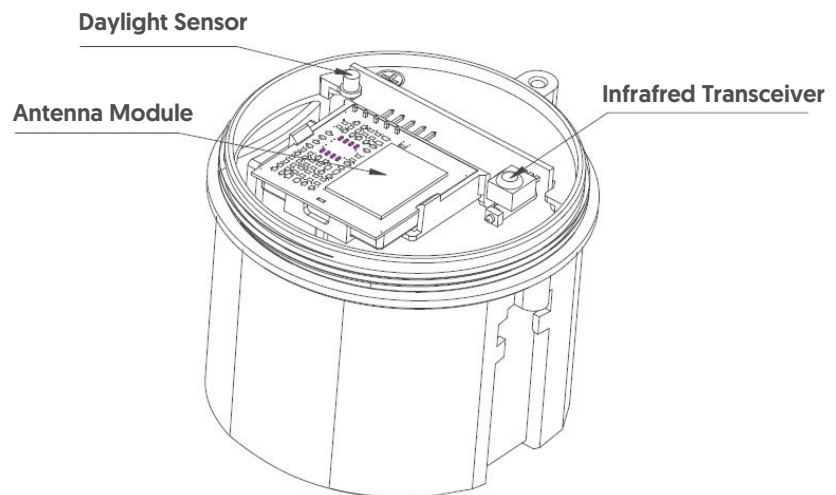

Glow UFO 170

Microwave Sensor

Radiation Patterns

Ceiling Mounted

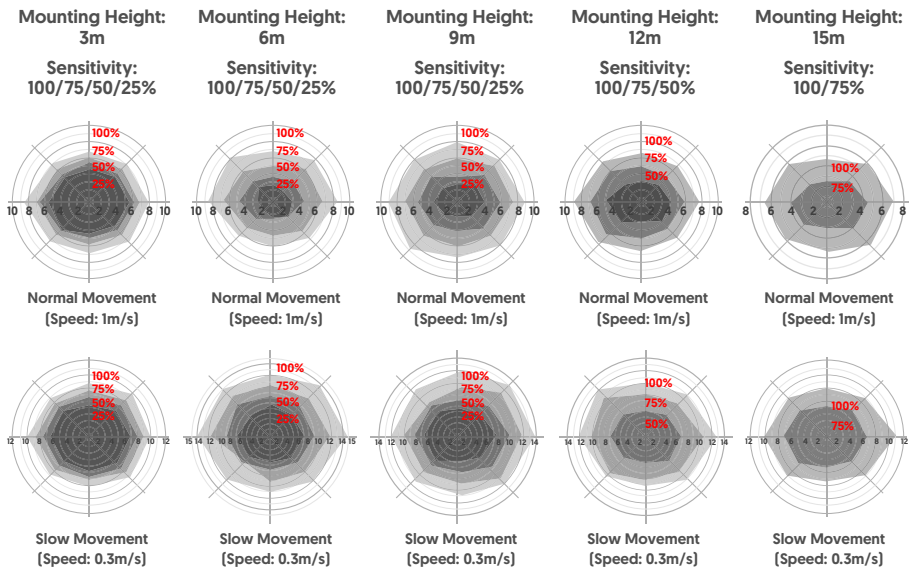

Note: Only 100%/75%/50% detection sensitivity is feasible when installed at 10m or 15m mounting height, as 25% will not detect motion.

Wall Mounted

Mounting Height: 2m
Sensitivity: 100/75/50/25%

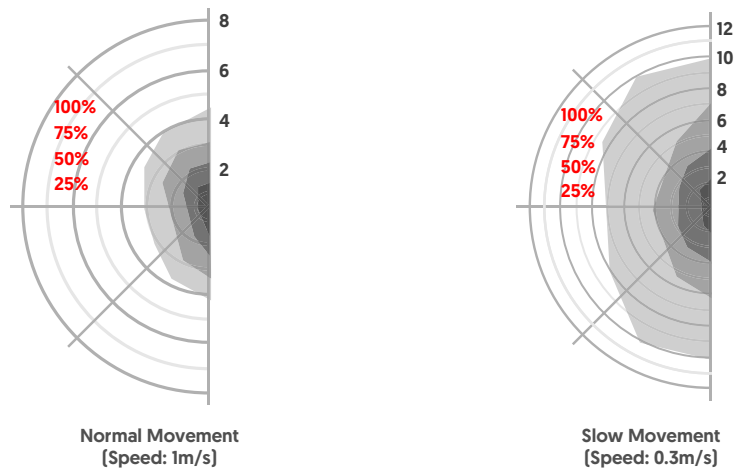

Glow UFO 170

Microwave Sensor

Remote Control

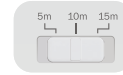
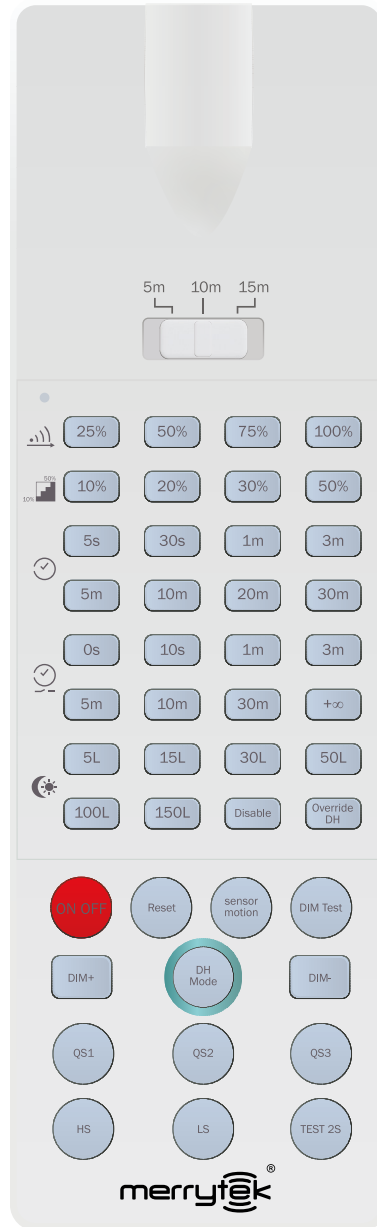

Remote distance toggle switch
(5m / 10m / 15m)



Set detection area
(25% / 50% / 75% / 100%)



Set stand-by dim level
(10% / 20% / 30% / 50%)



Set hold time
(5s / 30s / 1min / 3min / 5min / 10min / 20min / 30min)



Set stand-by period
(5s / 10s / 1min / 3min / 5min / 10min / 20min / 30min / +∞)



Set daylight sensor threshold
(5Lx / 15Lx / 30Lx / 50Lx / 100Lx / 150Lx / Disabled)



This button sets the sensor to constant on/off mode - meaning the sensor will not operate



Reset all parameters to factory settings



Use this button to set light back to sensor mode instead of on/off



A 2 second test to show whether the 1-10V ports are connected



Scene settings (see below)

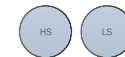

High sensitivity / low sensitivity



Test mode at 100% detection area, 5s hold-time, 10% stand-by dim level, 0s stand-by period, daylight sensor disabled



'Override DH', 'DH Mode' and any associated functions are not applicable to this sensor model

Scene Settings

Scene	Detection Area	Hold Time	Stand-by Period	Stand-by Dim Level	Daylight Sensor	Sensitivity Model
QS1	100%	5min	10min	10%	30Lx	High Sensitivity
QS2	100%	10min	30min	10%	Disable	High Sensitivity
QS3	100%	20min	30min	10%	Disable	High Sensitivity

Glow UFO 170

Microwave Sensor

Initialisation

1) On/off function or 3-step dimming function:

After switching on, the sensor will automatically be at 100% brightness. After 10 seconds, the light will turn off. During the initialisation process, the sensor will not detect movement.

2) 2-step dimming function:

After switching on, the sensor will automatically be at 100% brightness. After 10 seconds, the light will dim to a low level [set by stand-by dim level]. During the initialisation process, the sensor will not detect movement.

Factory Settings

- Detection Area: 100%
- Hold Time: 5s
- Stand-By Period: 0s
- Stand-By Dim Level: 10%
- Daylight Sensor: Disabled

Override Function

Switch power on and off 3 times to override the sensor functionality.
Switch on and off once to recover the sensor functionality.

Important Notes

- 1) The sensor should only be installed by a qualified electrician.
- 2) If the sensor is installed within a plastic or glass shade, sensitivity will reduce. Reduction can be 20% for every 3mm of housing thickness.
- 3) Power must be off before any installation, wiring, or changing of DIP switch settings takes place.
- 4) Dimming performance may differ depending on the 1-10V driver used.
- 5) The light sensitivity threshold is a daylight environment, with no shadow and ambient light diffusion reflections. Ambient lux levels could be compatible to various environments [weather, climate, time-of-day].
- 6) Parameters may need adjusting in certain environments. Be sure to carefully read the below notes before installing or adjusting.
- 7) The sensor is built for indoor use only. Wind, rain and moving objects may cause false triggering, and performance can be affected by water.
- 8) The sensor should always be at least 3m distance from other sensors
- 9) Do not place the sensor too close to high-density objects or materials, such as metals, glass, concrete, walls etc. Placing the sensor too close may cause false triggering. Installation within a metal fitting, metal reflective surface or inside a narrow enclosure may also cause false triggering [reduce the sensitivity, or avoid installing in these environments.]
- 10) To avoid false triggers, please ensure that there are no moving signals around the sensor. This may include fans, DC, motors, sewage pipes or air outlets.