

Glow UFO 170 High Bay

CODE: GU-170-240NW/EC



-  IP65 Ingress Protection
-  IK08 Impact Resistance
-  170 High LED Efficacy
-  1-10V Dimmable (as Standard)

Dimensions

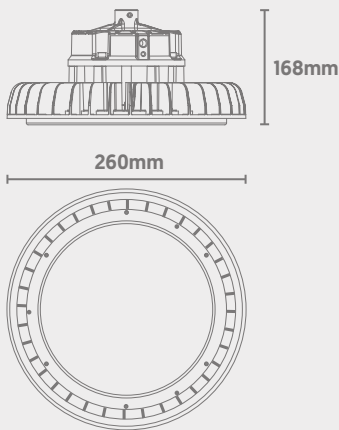

Power	Efficacy	Output	Kelvin
240W	170Lm/cW	40800Lm	4000K

Technical

Input Voltage	AC 100-277V
Colour Rendering Index	>70
Beam Spread	110°
Power Factor	>0.9
Operating Temp.	-30 to +50°C
Materials	Aluminium & Tempered Glass
IP Rating	IP65
IK Rating	IK08
Cable Flex	1.5m
Dimmable	1-10V (as Standard)
Dimensions	260mm x 168mm
Weight	3.1kg
MacAdam Step	<3
Lifetime	50,000 hours, L90-B10 (Ta 25 °C)
CE Standards	EN60598-1, EN 60598 2-5, EN62493, EN55015, EN61547, EN61000-3-2, EN61000-3-3, EN62722-1, EN62722-2-1 and EN50581
CE Directives	LVD, EMC, ERP & RoHS

A T G C Light Source Energy Rating

Photometric Data

